









コウザイ
INSTALLATION MATERIALS
CP26-01302

	ヒューズ [®] ハリマーク FUZE LABEL 03-153-1312-0 (100-292-140-10)	1
	FマウントスポンジV15 FLUSH MOUNTING SPONGE V 15 26-005-2124-0 (100-351-290-10)	2
	FマウントスポンジH15 FLUSH MOUNTING SPONGE H 15 26-005-2123-0 (100-351-280-10)	2
	コンベックス CONVEX CV-125N (000-172-164-10)	4
	+ナベ [®] セムS WASHER HEAD SCREW *B M4X10 SUS304 (000-163-836-10)	6

ヨビヒン
SPARE PARTS
SP26-00201

	ヒューズ [®] GLASS TUBE FUZE FGB0-A 125V 5A PBF (000-155-853-10)	3
	ヒューズ [®] GLASS TUBE FUZE FGB0 125V 10A PBF (000-155-826-10)	3

フゾクヒン
ACCESSORIES
FP26-00401

	フィルタークリーナー LCD CLEANING CLOTH 19-028-3125-0 (100-360-670-10)	1
---	---	---

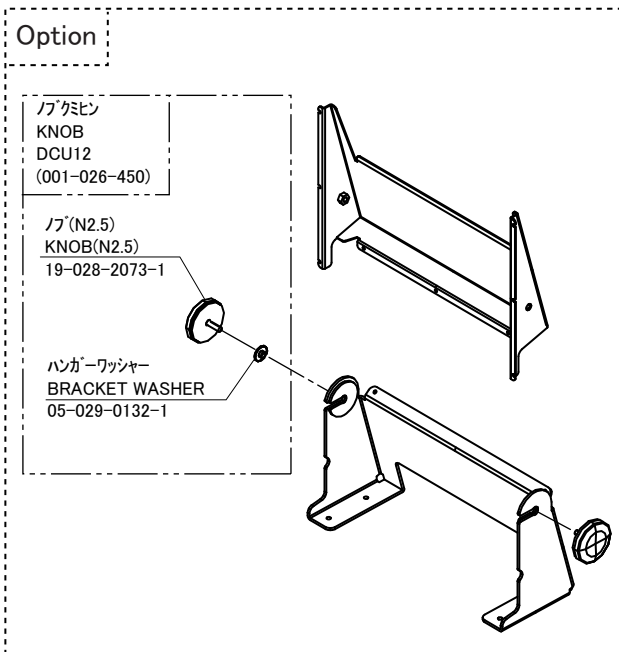
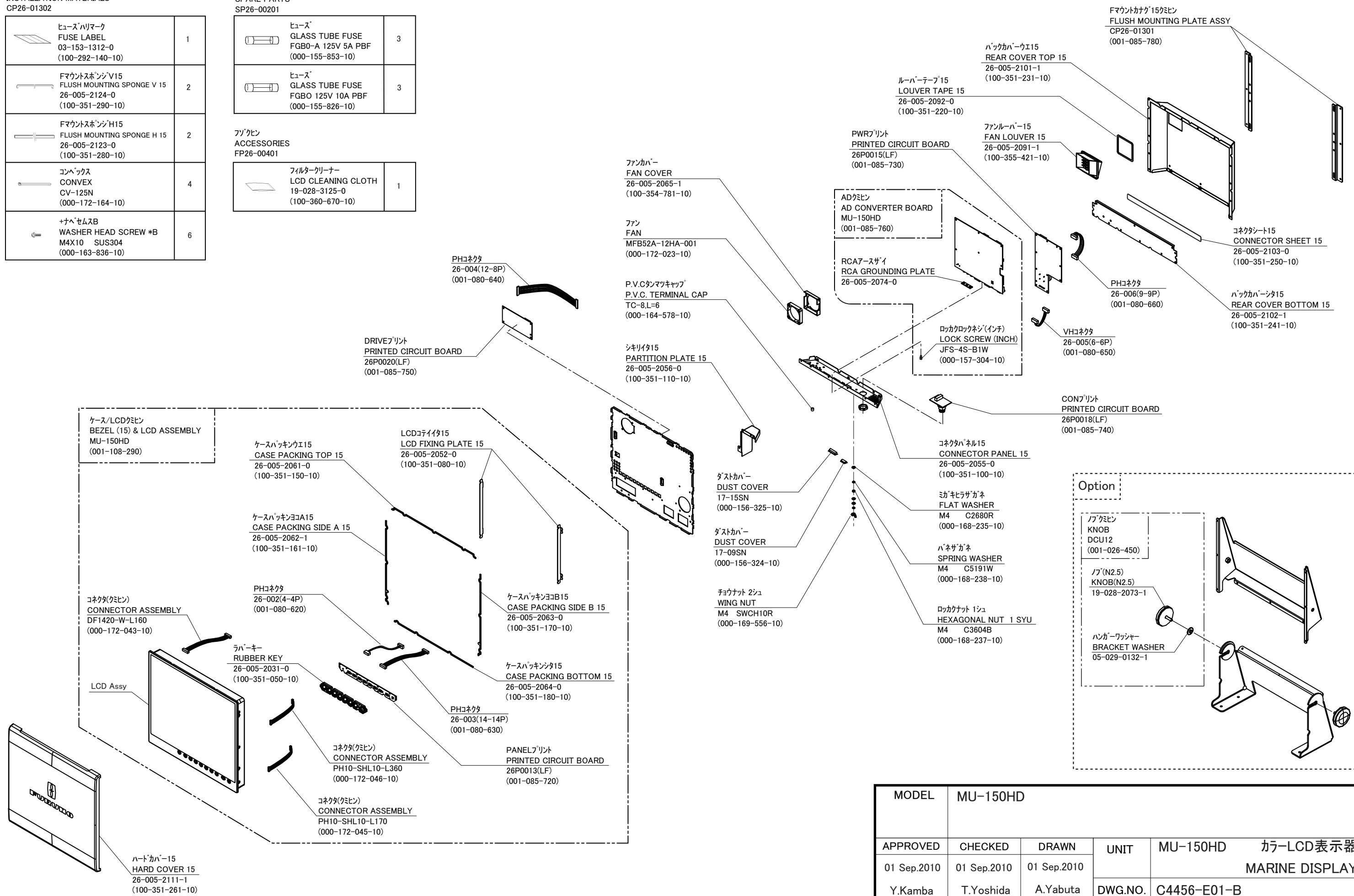

MODEL	MU-150HD				
APPROVED	CHECKED	DRAWN	UNIT	MU-150HD	カラーLCD表示器
01 Sep.2010	01 Sep.2010	01 Sep.2010			MARINE DISPLAY
Y.Kamba	T.Yoshida	A.Yabuta	DWG.NO.	C4456-E01-B	